



EvoCare[®]

Direct Connect Sensors
9 foot / 3m cable

Short Sensors
3 foot / 0.9m cable

SpO₂
Compatible SpO₂
probes, adapters
and accessories

Disposable Sensors
3 foot / 0.9m cable

Adapter Cables
10 or 12 feet / 3 or 3.6m cable

Adapter Cables
10 or 12 feet / 3 or 3.6m cable

Choosing your SpO2 probe



ADULT CLIP

Best for a secure fit
And for short term
Spot checking. Patient
Size : >40kg



ADULT SOFT

Best for patient
comfort and long
term care
Patient size: >40kg



PEDIATRIC CLIP

Better hold for
smaller fingers that
like to move.
Patient size 13 – 40 kg



PEDIATRIC SOFT

A softer grab
Long term monitor
Patient size: 13-40 kg



INFANT SOFT

A gentle option for the
smaller ones .
Patient Size : 3 – 13 kg



NEONATE WRAP

Gentle foot wrap
for newborns
Patient size: 1 -3 kg



MULTI SITE

A versatile option for all
Patient sizes. Apply on
Foot, finger or lobe



ADULT EAR CLIP

Best choice for
patients with low
perfusion or burns





ADULT FINGER WRAP

Alternative option
for adult, pediatric or
neonate.

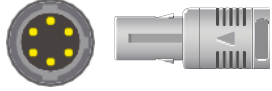
Adecon Direct Connect Sensors

Models	Connector	Options	Unimed-EVO	ORIGINAL	Evotec OEM
DK8000 DK8000C DK8000E DK8000E DK8000A	 6 PIN 1 BIT REDEL	Adult Clip	EV410-120		ES0164B-L
		Adult Soft	EV410S-120		ES0164D-L
		Pediatric Clip			ES0164C-L
		Pediatric Soft			ES0164E-L
		Neonate Wrap			ES0164I-L
		Multi-Site	EV810-120		ES0164G-L

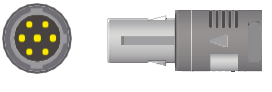
BCI Direct Connect Sensors

Models	Connector	Options	Unimed-EVO	ORIGINAL	Evotec OEM
3180, 3300, 3404, 3444, 6100, 9100, Advisor, Autocorr, Mini Torr, Mini Torr Plus; Larsen & Toubro Limited (L&T Medical) Stellar P, Star 50, Galaxy, Planet, Planet 50, Cosmic	 7 PIN 1 BIT REDEL	Adult Clip	EV410-760		ES0111B-L
		Adult Soft	EV410S-760		ES0111D-L
		Pediatric Clip	EV103-760		ES0111C-L
		Pediatric Soft	EV103S-760		ES0111E-L
		Neonate Wrap	EV310-760		ES0111I-L
		Multi-Site	EV810-760		ES0111G-L
3300, 3301, 3302, 3303, 3304, 3400, 3401, 3403, 9200; Spacelabs Burdick: PRO2; Drager: Oxipac 2000; MMedChoice: MD300A; Invacare 3300nv	 6 PIN	Adult Clip	EV410-060		ES0076B-L
		Adult Soft	EV410S-060		ES0076D-L
		Pediatric Clip	EV110-060		ES0076C-L
		Pediatric Soft	EV110S-060		ES0076E-L
		Neonate Wrap	EV310-060		ES0076I-L
		Multi-Site	EV810-060		ES0076G-L



BCI Short Sensors

Models	Connector	Options	Unimed-EVO	ORIGINAL	Evotec OEM
3180, 3401, 3304, 3303, 3302, 3301, 3300, 3400, 3403, Smiths Medical BCI Capnocheck 9004, Spectro 2 10, 20, 30, SurgiVet; Spacelabs Burdick: PRO2; Drager: Drager Oxipac 2000; Armstrong Medical AD-1000; Beijing Choice Electronic: Pulse Oximeter model MD300I1	 6 PIN	Adult Clip	EV403-060	3444	ES0076B-S
		Adult Soft	EV403S-060		ES0076D-S
		Pediatric Clip	EV103-060	3178	ES0076C-S
		Pediatric Soft	EV103S-060		ES0076E-S
		Neonate Wrap	EV303-060		ES0076I-S
		Multi-Site	EV8030-060		ES0076G-S

BCI Disposable Sensors

Models	Connector	Options	Unimed-EVO	ORIGINAL	Evotec OEM
	 6 PIN	Adult Box of 24	EV503-060	1300	ES0076J-S
		Pediatric Box of 24	EV523-060	1301	ES0076K-S
		Infant Box of 24	EV533-060	1303	ES0076L-S
		Neonate Box of 24	EV543-060	1302	ES0076M-S
		Comfort Box of 24			ES0076N-S

BCI Adapter Cables

Models	Connector	Options	Unimed-EVO	ORIGINAL	Evotec OEM
6100, 9100, Advisor, Autocorr, Mini Torr and Mini Torr Plus	To Monitor:  8 PIN 1 BIT REDEL To BCI Sensor: 	7 Foot Adapter	EV708-760		ES0111BC-L
					ES0076BC-L

3F IRIS Direct Connect Sensor

Models	Connector	Options	Unimed-EVO	ORIGINAL	Evotec OEM
M7000	 6 PIN 1 BIT REDEL	Adult Clip	EV410-68D0		ES0021B-L
		Adult Soft	EV410S-68D0		ES0021D-L
		Pediatric Clip	EV110-68D0		ES0021C-L
		Pediatric Soft	EV110S-68D0		ES0021E-L
		Neonate Wrap	EV310-68D0		ES0021I-L
		Multi-Site	EV810-68D0		ES0021G-L

3F PHOEBE Direct Connect Sensor

Models	Connector	Options	Unimed-EVO	ORIGINAL	Evotec OEM
	 8 PIN 1 BIT REDEL	Adult Clip	EV410-68D0		ES0022B-L
		Adult Soft	EV410S-68D0		ES0022D-L
		Pediatric Clip	EV110-68D0		ES0022C-L
		Pediatric Soft	EV110S-68D0		ES0022E-L
		Neonate Wrap	EV310-68D0		ES0022I-L
		Multi-Site	EV810-68D0		ES0022G-L

Biolight Direct Connect Sensors

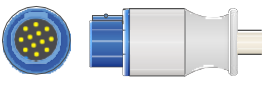
Models	Connector	Options	Unimed-EVO	ORIGINAL	Evotec OEM
M7000, M900, M9500 A8 MODULAR *DIGITAL TECH		Adult Clip	EV410-68D0		ES0150B-L
		Adult Soft	EV410S-68D0		ES0150D-L
		Pediatric Clip	EV110-68D0		ES0150C-L
		Pediatric Soft	EV110S-68D0		ES0150E-L
		Neonate Wrap	EV310-68D0		ES0150I-L
		Multi-Site	EV810-68D0		ES0150G-L

Biolight Direct Connect Sensors

Models	Connector	Options	Unimed-EVO	ORIGINAL	Evotec OEM
M6, M12,M69	 5 PIN 1 BIT REDEL	Adult Clip	EV410-47		ES0029B-L
		Adult Soft	EV410S-47		ES0029D-L
		Pediatric Clip			ES0029C-L
		Pediatric Soft			ES0029E-L
		Neonate Wrap			ES0029I-L
		Multi-Site	EV810-47		ES0029G-L

Biolight Direct Connect Sensors

Models	Connector	Options	Unimed-EVO	ORIGINAL	Evotec OEM
8000, 9000, 8000A, 9000A, BTD-352A NEW M69	 5 PIN 1 BIT REDEL	Adult Clip	EV410-62D		ES0155B-L
		Adult Soft	EV410S-62D		ES0155D-L
		Pediatric Clip			ES0155C-L
		Pediatric Soft			ES0155E-L
		Neonate Wrap			ES0155I-L
		Multi-Site	EV810-62D		ES0155G-L

Biolight Direct Connect Sensors

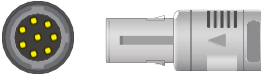
Models	Connector	Options	Unimed-EVO	ORIGINAL	Evotec OEM
OXIMAX	 5 PIN 1 BIT REDEL	Adult Clip	EV410-51P		
		Adult Soft	EV410S-51P		
		Pediatric Clip			
		Pediatric Soft			
		Neonate Wrap			
		Multi-Site	EV810-51P		

Biolight Direct Connect Sensors

Models	Connector	Options	Unimed-EVO	ORIGINAL	Evotec OEM
V6 - OXIMAX	 5 PIN 1 BIT REDEL	Adult Clip			ESO151B-L
		Adult Soft			ESO151D-L
		Pediatric Clip			ESO151C-L
		Pediatric Soft			ESO151E-L
		Neonate Wrap			ESO151I-L
		Multi-Site			ESO151G-L

Bionet Direct Connect Sensors

Models	Connector	Options	Unimed-EVO	ORIGINAL	EVOTEC OEM
BM3 BM5 OLD		Adult Clip	EV410-58		ES0084B-L
		Adult Soft	EV410S-58		ES0084D-L
		Pediatric Clip	EV110-58		ES0084C-L
		Pediatric Soft	EV110S-58		ES0084E-L
		Neonate Wrap	EV310-58		ES0084I-L
		Multi-Site	EV810-58		ES0084G-L
BM3 BM5 NEW		Adult Clip	EV410-108		ES0121B-L
		Adult Soft	EV410S-108		ES0121D-L
		Pediatric Clip	EV110-108		ES0121C-L
		Pediatric Soft	EV110S-108		ES0121E-L
		Neonate Wrap	EV310-108		ES0121I-L
		Multi-Site	EV810-108		ES0121G-L

Bionet Adapter Cables

Models	Connector	Options	Unimed-EVO	ORIGINAL	EVOTEC OEM
BM3, BM3 Plus	To Monitor: To Nellcor non-Oximax Sensor: 	7 Foot Adapter	EV708-580		EV0084BC-L
					EC0121BC-L

Biocare Direct Connect Sensors

Models	Connector	Options	Unimed-EVO	ORIGINAL	EVOTEC OEM
BP-12B, BP-12C • DIGITAL TECH	 5 PIN 2 BIT 80DEG REDEL	Adult Clip	EV410-61D		ES0205B-L
		Adult Soft	EV410S-61D		ES0205D-L
		Pediatric Clip			ES0205C-L
		Pediatric Soft			ES0205E-L
		Neonate Wrap			ES0205I-L
		Multi-Site	EV810-61D		ES0205G-L
BM-9000, BM9000S, FM-801 FM-801V • DIGITAL TECH	 5PIN 1BIT REDEL	Adult Clip	EV410-62D		ES0155B-L
		Adult Soft	EV410S-62D		ES0155D-L
		Pediatric Clip			ES0155C-L
		Pediatric Soft			ES0155E-L
		Neonate Wrap			ES0155I-L
		Multi-Site	EV810-62D		ES0155G-L



Biocare Direct Connect Sensors

Models	Connector	Options	Unimed-EVO	ORIGINAL	Evotec OEM
BM-9000	 5PIN 1BIT REDEL	Adult Clip	EV410-29		ES0007B-L
OLD TYPE		Adult Soft	EV410S-29		ES0007D-L
		Pediatric Clip			ES0007C-L
		Pediatric Soft			ES0007E-L
		Neonate Wrap			ES000I-L
		Multi-Site	EV810-29		ES0007G-L

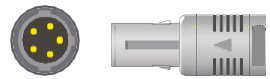
ChoiceMed Direct Connect Sensors

Models	Connector	Options	Unimed-EVO	ORIGINAL	Evotec OEM
BM-9000 DIGITAL TECHNOLOGY	 6PIN 1 BIT REDEL	Adult Clip	EV410-84D		EV410-84D
		Adult Soft	EV410S-84D		EV410S-84D
		Pediatric Clip			
		Pediatric Soft			
		Neonate Wrap			
		Multi-Site	EV810-84D		EV810-84D
Mmed 6000 BCI TECHNOLOGY	 5PIN 1 BIT REDEL	Adult Clip	EV410-96		ES0007B-L
		Adult Soft	EV410S-96		ES0007D-L
					ES0007C-L
					ES0007E-L
		Multi-Site	EV810-96		ES0007G-L

ChoiceMed Direct Connect Sensors

Models	Connector	Options	Unimed-EVO	ORIGINAL	Evotec OEM
MMED2000A		Adult Clip			ESO162B-S
		Adult Soft			ESO162D-S
		Pediatric Clip			ESO162C-S
		Pediatric Soft			ESO162E-S
		Neonate Wrap			ESO162I-S
		Multi-Site			ESO162G-S
MMED 2000B		Adult Clip			ES0163B-L
		Adult Soft			ES0163D-L
		Pediatric Clip			ES0163C-L
		Pediatric Soft			ES0163E-L
		Neonate Wrap			ES0163I-L
		Multi-site			ES0163G-L

ChoiceMed Short Sensors

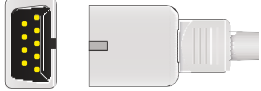
Models	Connector	Options	Unimed-EVO	ORIGINAL	Evotec OEM
MMED 3001		Adult Clip	EV403-01	DS100A	ESO132B-S
		Adult Soft	EV403S-29	DS100A	ESO132D-S
		Pediatric Clip			ESO132C-S
		Pediatric Soft			ESO132E-S
		Neonate Wrap			ESO132I-S
		Multi-Site	EV803-29	D-YS	ESO132G-S

Contec Direct Connect Sensors

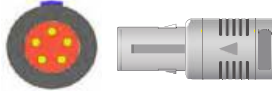
Models	Connector	Options	Unimed-EVO	ORIGINAL	Evotec OEM
Creative: PC9000,UP6000 TOB-MED: TOM MS-6-P EDAN:M9,M99A,M8,M8A,M8B, M3, M 3B BIOCARE: BM9000 Goldway; CONTEC; DHR960;	40 deg  6pin 2 bit redel	Adult Clip	EV410-46D		ESO063B-L
		Adult Soft	EV410S-46D		ESO063D-L
		Pediatric Clip			ESO063C-L
		Pediatric Soft			ESO063E-L
		Neonate Wrap			ESO063I-L
		Multi-Site	EV810-46D		ESO063G-L
Contec: CMS8000, CMS 60C *digital PD output directly DS. Biolight: M6, M69 SEE BIOCARE BM9000 DIGITAL TECHNOLOGY	 6pin 1 bit redel	Adult Clip	EV410-29		ESO155B-L
		Adult Soft	EV410S-29		ESO155D-L
		Pediatric Clip			ESO155C-L
		Pediatric Soft			ESO155E-L
		Neonate Wrap			ESO155I-L
		Multi Site	U810-29		ESO155G-L

Contec Direct Connect Sensors

Models	Connector	Options	Unimed-EVO	ORIGINAL	Evotec OEM
CMS50F/CMS50FW		Adult Clip	EV401-149		ESO149B-L
		Adult Soft	EV401S-149		ESO149D-L
		Pediatric Clip			
		Pediatric Soft			
		Neonate Wrap			
		Multi-Site			

Creative Direct Connect Sensors

Models	Connector	Options	Unimed-EVO	ORIGINAL	Evotec OEM
Creative: PC9000,UP6000 TOB-MED: TOM MS-6-P EDAN:M9,M99A,M8,M8A,M8B,M 3,M3B Goldway CONTEC DHR960	 6pin 2 bit 40 deg	Adult Clip	EV401-149		ESO063B-L
		Adult Soft	EV401S-149		ESO063D-L
		Pediatric Clip			ESO063C-L
		Pediatric Soft			ESO063E-L
		Neonate Wrap			ESO063I-L
		Multi-Site			ESO063G-L



Creative Direct Connect Sensors

Models	Connector	Options	Unimed-EVO	ORIGINAL	Evotec OEM
PC900, PC900A, PC900 colour, PC3000 patient monitor DIGITAL PD directly DS NON Oximax	 6pin 2 bit 60 deg	Adult Clip	EV410-29		ES0160B-L
		Adult Soft	EV410S-29		ES0160D-L
		Pediatric Clip			ES0160C-L
		Pediatric Soft			ES0160E-L
		Neonate Wrap			ES0160I-L
		Multi-Site	EV810-29		ES0160G-L

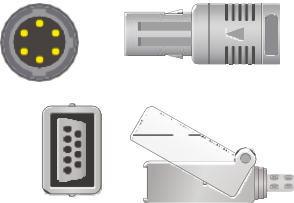
Creative Direct Connect Sensors

Models	Connector	Options	Unimed-EVO	ORIGINAL	Evotec OEM
UP-7000,UP-9000,PC-900, PC-900A,PC-900S PC-900SNPC-3000, PC-5000A/B,PC-9000B, PC-66A, PC-66B, PC-66V(*Digital tech)	 6pin 2 bit 80 deg	Adult Clip	EV410-61D		ES0205B-L
		Adult Soft	EV410S-61D		ES0205D-L
		Pediatric Clip			ES0205C-L
		Pediatric Soft			ES0205E-L
		Neonate Wrap			ES0205I-L
		Multi-Site	EV810-61D		ES0205G-L



Criticare Direct Connect Sensors

Models	Connector	Options	Unimed-EVO	ORIGINAL	EVOTEC OEM
Alaris 4415 (IVAC): VitalCheck 4400, 4410; Criticare: 503DX-W, 503S, 503DX, 503 Spot, 504DX/P, 504DX, 506 series (except 506LN3), 507ELC2, 8000 series, 8100 series, Poet Plus, Poet R Plus, Poet (602- 3A), Scholar, Scholar III, nGenuity		Adult Clip	EV410-750	934-10DN	ES0044B-L
		Adult Soft	EV410S-750	975AD-10	ES0044D-L
		Pediatric Clip	EV110-750	1563-10D	ES0044C-L
		Pediatric Soft	EV110S-750	975PD-10	ES0044E-L
		Neonate Wrap	EV310-750		ES0044I-L
		Multi-Site	EV810-750		ES0044G-L
Scholar, Poet (602-3A), 1100, 2200, 500, 500A 501, 502 series, 503, 504, 504/P, 504O/P, 504US/P, 507, 507E/P/R, 507/S, 507SD, 5070/P, 508, 509, 581		Adult Clip	EV410-050	934-10LN	ES0100B-L
		Adult Soft	EV410S-050	975AD-10L	ES0100D-L
		Pediatric Clip	EV110-050	1563-10L	ES0100C-L
		Pediatric Soft	EV110S-050	975PD-10L	ES0100E-L
		Neonate Wrap	EV310-050		ES0100I-L
		Multi-Site	EV810-050	940-10L	ES0100G-L

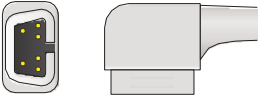
Criticare Disposable Sensors

Models	Connector	Options	Unimed-EVO	ORIGINAL	EVOTEC OEM
		Adult Box of 24	EV503-050	570SD	ES0044J-S
		Pediatric Box of 24	EV523-050	571SD	ES0044K-S
		Infant Box of 24	EV533-050	572SD	ES0044L-S
		Neonate Box of 24	EV543-050	573SD	ES0044M-S

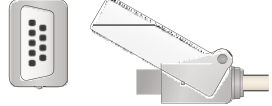

Criticare Adapter Cables

Models	Connector	Options	Unimed-EVO	ORIGINAL	EVOTEC OEM
506 Spot CSI, 507SD, 503 Spot	<p>To Monitor:</p>  <p>To Criticare Sensor:</p> 	7 Foot Adapter	EV708-750	518DD	ES0044BC-L
Scholar, Poet (602-3A), 1100, 581, 508, 507, 507SD, 504, 503, 501; Mindray: 500A	<p>To Monitor:</p>  <p>To Criticare Sensor:</p> 	7 Foot Adapter	EV708-050	518LD	ES0100BC-L

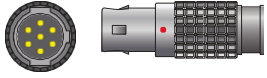
Critikon Direct Connect Sensors

Models	Connector	Options	Unimed-EVO	ORIGINAL	EVOTEC OEM
Dinamap 8700, 8710, 8720 Pulse, 8721, 9710, 9700, 8280 and Oxyshuttle	 7 PIN LEMO	Adult Clip	EV410-10		ES0059B-L
		Adult Soft	EV410S-10		ES0059D-L
		Pediatric Clip	EV110-10		ES0059C-L
		Pediatric Soft	EV110S-10		ES0059E-L
		Neonate Wrap	EV310-10		ES0059I-L
		Multi-Site	EV810-10		ES0059G-L

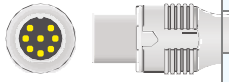

Datascope Direct Connect Sensors

Models	Connector	Options	Unimed-EVO	ORIGINAL	EVOTEC OEM
Accusat, Accutorr 3 SAT, Accutorr 4 SAT, Accutorr Plus, Passport, Passport 2, Passport 2LT, Passport 5L, Passport IL, Passport EL, Passport XL, Passport XG, Datascope Multinex Plus Monitor, Datascope 3000, Passport D	 8 PIN DIN	Adult Clip	EV410-07	0600-00-0026-02, 0020-00-071-01, 90651A-	ES0052B-L
		Adult Soft	EV410S-07		ES0052D-L
		Pediatric Clip	EV110-07		ES0052C-L
		Pediatric Soft	EV110S-07		ES0052E-L
		Neonate Wrap	EV310-07		ES0052I-L
		Multi-Site	EV810-07		ES0052G-L
Datascope Duo, Trio and Datascope Passport XG, DPM1, DPM2, DPM3, DPM4, DPM5, DPM6, DPM7; ARI 800B; Advanced PM1000F	 6PIN 2 BIT 40DEG REDEL	Adult Clip	EV410-29	0600-00-0094	
		Adult Soft	EV410S-29		
		Pediatric Clip	EV110-29		
		Pediatric Soft	EV110S-29		
		Neonate Wrap	EV310-29		
		Multi-Site	EV810-29	0600-00-0093	

Datascope Direct Connect Sensors

Models	Connector	Options	Unimed-EVO	ORIGINAL	EVOTEC OEM
Accutor Plus • Massimo Tech	 15 pin 3M connector	Adult Clip	EV410-15		ES0020B-L
		Adult Soft	EV410S-15		ES0020D-L
		Pediatric Clip			ES0020C-L
		Pediatric Soft			ES0020E-L
		Neonate Wrap			ES0020I-L
		Multi-Site	EV810-15		ES0020G-L

Datascope Short Sensors

Models	Connector	Options	Unimed-EVO	ORIGINAL	EVOTEC OEM
Accusat, Accutorr 3 SAT, Accutorr 4 SAT, Accutorr Plus, Passport, Passport 2, Passport 2LT, Passport IL, Passport XL and Passport XG		Adult clip	EV403-07	0600-00-0026-01	
		Adult soft	EV403S-07		
		Pediatric clip	EV103-07		
		Pediatric soft	EV103S-07		
		Neonate Wrap	EV303-07		
		Multi-Site	EV803-07		
Accutorr 3/4 SAT, Accutorr Plus		Adult Clip		0020-00-071-01	ES0052B-S
		Adult Soft			ES0052D-S
		Pediatric Clip			ES0052C-S
		Pediatric Soft			ES0052E-S
		Neonate Wrap			ES0052I-S
		Multi Site			ES0052G-S

Datascope Disposable Sensors

Models	Connector	Options	Unimed-EVO	ORIGINAL	EVOTEC OEM
		Adult Box of 24	EV503-07	0998-00-0076-05	
		Pediatric Box of	EV523-07	0998-00-0076-04	ES0052K-S
		Infant Box of 24	EV533-07	0998-00-0074-03	
		Neonate Box of	EV543-07	0998-00-0074-04	ES0052K-S

Datascope Adapter Cables

Models	Connector	Options	Unimed-EVO	ORIGINAL	EVOTEC OEM
Accusat, Accutorr 3 SAT, Accutorr 4 SAT, Accutorr Passport 2LT, Passport IL, Passport XG	To Monitor:	7 Foot Adapter	EV708-07	0012-00-0516-02	EV0052BC-L
	To Datex Ohmeda DB9 Sensor:				
					

Datex Ohmeda (GE HEALTH) Direct Connect Sensors

Models	Connector	Options	Unimed-EVO	ORIGINAL	EVOTEC OEM
Aespire, Aespire 15, AS/3, AS/3 Compact, CS/3, S/5, S/5 Compact, CH/S, CH/2S, CH-RS, CG/2S, Cardiocap I, Cardiocap II, Cardiocap 5, Capnomac Ultima, Light Monitor, M-Estpr, Oscar II, OSP-200, Satellite Trans, Satellite, Satellite Plus II, Trans Plus, System 5, ULTS00, OXY-E4-N, ULTSIO, ULTSVI, ULTSVO		Adult Clip	EV410-09	OXY-F4-N, SAF-F4, TS-F4-N	ES0036B-L
		Adult Soft	EV410S-09		ES0036D-L
		Pediatric Clip	EV110-09		ES0036C-L
		Pediatric Soft	EV110S-09		ES0036E-L
		Neonate Wrap	EV310-09	OXY-W4-N	ES0036I-L
		Adult Ear Clip	EV910-09	OXY-E4-N, TS-E4-N	ES0036G-L
		Multi-Site	EV810-09		ES0036G-L
3700, 3710, 3740, 3770, 3775, 3800,4700, 5250 RGM, OxiCap, Biox 3740, Biox 3760, Rascal II, Datex Ohmeda TuffSat 3775, 37xx Series, 3800, 3900, 3900P,4700 and 5250 respiratory gas monitors Cardiocap/5 with N-XOSAT option, S/5, AS/3, CS/3 Modular Monitors with M-OSAT module, Modulus CD; GE 7000 Series, Corometrics 511, TRAM A.R.,OXY-W4-H, TRAM Modular x00SL Series, 200SL, 400SL, 600SL, 800A, 800SL;Mennen: Horizon XL800 (Ohmeda SpO2)		Adult Clip (9 Feet)	EV410-02	OXY-F4-H, 6051-0000-035	ES0014B-L
		Adult Soft (9 Feet)	EV410S-02		ES0014D-L
		Pediatric Clip (9 Feet)	EV110-02		ES0014C-L
		Pediatric Soft (9 Feet)	EV110S-02		ES0014E-L
		Neonate Wrap (9 Feet)	EV310-02	OXY-W4-H, 0380-1000-080, 0380-1000-081	ES0014I-L
		Adult Ear Clip (9 Feet)	EV910-02	OXY-E4-H, 0380-1000-021, 6051-0000-188	ES0014G-L
Ohmeda TruSat Ohmeda TruSat TD (*+Oxytip+ Technology)		Adult clip	EV410-60		ES0127B-L
		Adult soft	EV410S-60		ES0127D-L
		Pediatric clip	EV110-60		ES0127C-L
		Pediatric soft	EV110S-60		ES0127E-L
		Neonate Wrap	EV310-60		ES0127I-L
		Adult Ear Clip	EV910-60		ES0127G-L+CLIP
		Multi-Site	EV810-60		ES0127G-L

Datex Ohmeda (GE HEALTH) Short Sensors

Models	Connector	Options	Unimed-EVO	ORIGINAL OEM #	EVOTEC OEM
AS/3, CS/3, CH/S, CH/2S, CH-RS, SAF-F, CG/2S, Cardiocap I, Cardiocap II, Cardiocap 5, Capnomac Ultima, Light Monitor, M-Estpr, Oscar II, OSP-200, Satellite Trans, Satellite, Satellite Plus II, Trans Plus, System 5, ULTS00, ULTSIO, ULTSVI, ULTSVO		Adult clip	EV403-09	OXY-F-DB, SAS-F	ES0014B-S
		Adult soft	EV403S-09		ES0014D-S
		Pediatric clip	EV103-09		ES0014C-S
		Pediatric soft	EV103S-09		ES0014E-S
		Neonate Wrap	EV303-09	OXY-W-DB, SAS-W	ES0014I-S
		Adult Ear Clip	EV903-09	OXY-E-DB, SAS-E	ES0014G-S
		Multi-Site	EV803-09		ES0014G-S
Trusignal CARESCAPE* modular monitors and S/5, AS/3 and CS/3 modular monitors with E-(P)RESTN or EPSM(P) modules. CARESCAPE V100 with TruSignal* option, Responder, B20 and B30 monitors.		Adult clip			ES0190B-S
		Adult soft			ES0190D-S
		Pediatric clip			ES0190C-S
		Neonate Wrap			ES0190E-S
		Adult Ear Clip			ES0190G-S+CLIP
		Multi-site			ES0190G-S





Datex Ohmeda (GE HEALTH) Disposable Sensors

Models	Connector	Options	Unimed-EVO	ORIGINAL	EVOTEC OEM
AS/3, CS/3, CH/S, CH/2S, CH-RS, SAF-F, CG/2S, Cardiocap I, Cardiocap II, Cardiocap 5, Capnomac Ultima, Light Monitor, M-Estpr, Oscar II, OSP-200, Satellite Trans, Satellite, Satellite Plus II, Trans Plus, System 5, ULTS00, ULTSIO, ULTSVI, ULTSVO		Adult Box of 24	EV503-09	SAS-AF	ES0036J-S
		Pediatric Box of 24	EV523-09	SAS-AP	ES0036K-S
		Infant Box of 24	EV533-09	SAS-AP	ES0036L-L
		Neonate Box of 24	EV543-09	SAS-AF	ES0036M-L



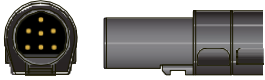
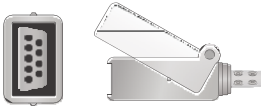
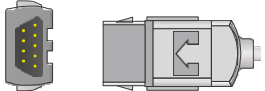
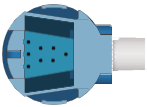

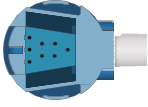
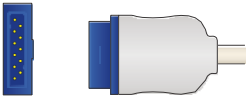
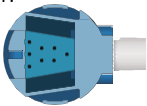

Datex Ohmeda (GE HEALTH) Adapter Cables

Models	Connector	Options	Unimed-EVO	ORIGINAL	EVOTEC OEM
S/5, AS/3, CS/3 Modular Monitors with M-series modules, Cardiocap/5, Cardiocap S/5 Light Monitor, Capnomac Ultima, Satellite Plus II	To Monitor: To Datex Ohmeda DB9 Sensor: 	2.2M Adapter	EV708-09	OXY-C3	EV0036BC-L
	To Monitor: To GE TruSignal Sensor: 	2.2M Adapter	EV708-112	TS-H3	EV0014BC-L
	To Monitor: To GE TruSignal Sensor: 	2.2M Adapter	EV708-116	TS-M3	EV0127TC-L
	To Monitor: To GE TruSignal Sensor: 	2.2M Adapter	EV708-119	TS-N3	EV0036TC-L

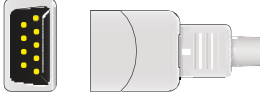
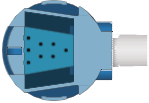



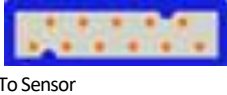

Datex Ohmeda Adapter Cables (Continued)

Models	Connector	Options	Unimed-EVO	ORIGINAL	EVOTEC OEM
	<p>To Monitor:</p>  <p>To Datex Ohmeda DB9 Sensor:</p> 	2.2M Adapter	EV708-72		EV0014BC-L
Use TruSat monitors that require OxyTip+ sensors including Datex Ohmeda TruSat and Datex Ohmeda TruSat TD	<p>To Monitor:</p>  <p>To Datex Ohmeda OxyTip+ Sensor:</p> 	2.2M Adapter	EV708-16	OXY-MC3	EV0127OH-L
TuffSat, 3775, 37xx Series, 3800, 3900, 3900P, 4700 and 5250 respiratory gas monitors, Cardiocap/5 with N-XOSAT option, S/5, AS/3, CS/3 Modular Monitors with M-OSAT module	<p>To Monitor:</p>  <p>To GE TruSignal Sensor:"</p> 	2.2M Adapter	EV708-102	OXY-OL3	EV0014OH-L
Monitors that require OxyTip+ sensors including S/5, AS/3, CS/3 Modular Monitors with M-series modules, Cardiocap/5, Cardiocap S/5 Light Monitor, Capnomac Ultima, Satellite Plus II	<p>To Monitor:</p>  <p>To Datex Ohmeda OxyTip+ Sensor:</p> 	2.2M Adapter	EV708-209	OXY-SL3	EV0036OH-L
S/5, i4 Modular Monitors with E-series modules, Corometrics 259 with TruSignal technology	<p>To Monitor:</p>  <p>To Datex Ohmeda OxyTip+ Sensor:</p> 	2.2M Adapter	EV708-121	OXY-ES3	EV0128OH-L

Datex Ohmeda (GE HEALTH) (Adaptor Cables Continue)

Models	Connector	Options	Unimed-EVO	ORIGINAL	EVOTEC OEM
Use Oxytip, Oxy-C3 connectors	<p>To Monitor:</p>  <p>To Datex Ohmeda OxyTip+ Sensor:</p> 	2.2M Adapter	EV708-81	OXY-SLA, OXY-SLC	
<p>Nellcor – NON Oximax</p> <p>Dash 2000/3000/4000 with Nellcor option, Dash 3000 /4000 /5000 with Ohmeda option, Solar 8000/8000M, i/9500 with Tram Module 451/451N/851/851N, CardioLab®/Mac-Lab® with Tram Module 451/451N Corometrics® 120/2120 series Eagle 1000/ 3000/ 4000 Responder 3000 with Nellcor option</p>	<p>To Monitor</p>  <p>Sensor side</p> 	2.2 meter	EV708-21	2006644-001	ES0002NE-L
<p>OXIMAX</p> <p>Dash 3000/4000/5000 with Nellcor OxiMax option Solar 8000/8000M, i9500 with Tram module 451N5/851N5;</p>	<p>To Monitor</p>  <p>To sensor</p> 	3.0 meter	EV710X-21	2021406-001	ES0122OX-L
<p>M-Technology (MASSIMO)</p> <p>Dash 3000/4000/5000 with Masimo option Solar 8000/8000M, i/9500 with Tram Module 451M/851M CardioLab®/Mac-Lab® with Tram Module 451M Corometrics® 259;</p>	<p>To monitor</p>  <p>To Sensor</p> 	2.2 meter	EV708-21M	M technology 2017002-003	ES0025CO-L (Use with ES0010B-S)

Datex Ohmeda (GE HEALTH) (Adaptor Cables Continue)

Models	Connector	Options	Unimed-EVO	ORIGINAL	EVOTEC OEM
M-TECH (Massimo LNCS) Dash 3000/4000/5000 with Masimo option Solar 8000/8000M, i/9500 with Tram Module 451M/851M CardioLab®/Mac-Lab® with Tram Module 451M Corometrics® 259;	To Monitor   To sensor 	2.2 meter	EV708-21	LNC-10-GE 2027263-002 (Ref 2016)	ES0025CS-L (Use together with ES0153B-S)
M-TECH (Massimo LNCS) Dash 3000/4000/5000 with Masimo option Solar 8000/8000M, i/9500 with Tram Module 451M/851M CardioLab®/Mac-Lab® with Tram Module 451M Corometrics® 259;	To Monitor   To Sensor 	2.2 meter	EV708-21P	20169041-001	ES0025MA-L Use with original Massimo LNOP probes

Dinamap (See Nellcor and Marquette)

Dolphin Short Sensors

Models	Connector	Options	Unimed-EVO	ORIGINAL	EVOTEC OEM
Dolphin ONE Oximeters 210, 2150, 2100, 2G00751		Adult clip	EV403-50D	201, 360, 360	ES0099B-S
		Adult soft	EV403S-50D		ES0099D-S
		Pediatric Clip			ES0099C-S
		Pediatric Soft			ES0099E-S
		Neonatal Wrap			ES0099I-S
		Multi - Site			ES0099G-S

Dolphin Adapter Cables

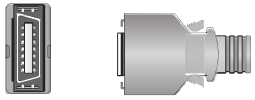
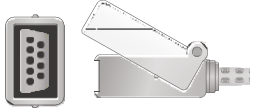
Models	Connector	Options	Unimed-EVO	ORIGINAL	EVOTEC OEM
	To Monitor:  To Dolphin Sensor: 	2.2 meter	EV708-50		ES0099BC-L

Drager Direct Connect Sensors

Models	Connector	Options	Unimed-EVO	ORIGINAL	EVOTEC OEM
Siemens, Sirecust 700, Sirecust 630, Sirem SpO2 Module		Adult Clip	EV410-33		ES0078B-L
		Adult Soft	EV410S-33		ES0078D-L
		Pediatric Clip	EV110-33		ES0078C-L
		Pediatric Soft	EV110S-33		ES0078E-L
		Neonate Wrap	EV310-33		ES0078I-L
		Multi-Site	EV810-33		ES0078G-I
SC6002XL, 7000, SC8000, SC9000X, Infinity Vista and Infinity Delta	 	Adult Clip	EV410-23		ES0072-L
		Adult Soft	EV410S-23		ES0072D-L
		Pediatric Clip	EV110-23		ES0072C-L
		Pediatric Soft	EV110S-23		ES0072E-L
		Neonate Wrap	EV310-23		ES0072I-L
		Multi-Site	EV810-23		ES0072G-L



Drager Adapter Cables

Models	Connector	Options	Unimed-EVO	ORIGINAL	EVOTEC OEM
Sirecust 700, Sirecust 630, Sirem SpO2 Module	To Monitor: To Nellcor non-Oximax Sensor: 	7 Foot Adapter	EV708-330		ES0078BC-L
Infinity Vista, Delta, Gamma, Kappa MultiMed Pod; Siemens SC 6002XL, SC7000, SC8000, SC9000XL	To Monitor: To Nellcor non-Oximax Sensor: 	7 Foot Adapter	EV708-230	3368433, 3375834	ES0072BC-L
Infinity Vista, Delta, Gamma and Kappa MultiMed Pod for Nellcor Oximax sensor	To Monitor: To Nellcor Oximax Sensor: 	10 Foot Adapter	EV710P-230	MS17330	ES0073BC-L

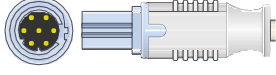
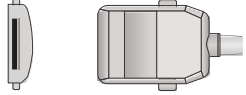
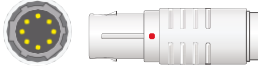
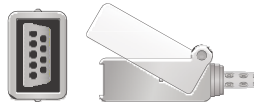

Drager Adapter Cables (continue)

Models	Connector	Options	Unimed-EVO	ORIGINAL	EVOTEC OEM
Infinity Vista, Delta, Gamma and Kappa MultiMed Pod	To Monitor:  To Masimo LNOP Sensor: 	2.2m Adapter	EV708M-23P0	MS17041	
Vitalert 1000, Cicero, Julian	To Monitor:  To Nellcor non-Oximax Sensor: 	2.2m Adapter	EV708-280	M35371, M35370, 5720084	ES0119BC-L





Edan Direct Connect Sensors (Also see Mindray)

Models	Connector	Options	Unimed-EVO	ORIGINAL	EVOTEC OEM
M3, M3B, M8, M8A, M8B, M9, M9A, M50, M80, iM9, iM9A, iM50, iM80 with Oximax technology OXIMAX TECHNOLOGY	 8 PIN 1 BIT REDEL	Adult Clip	EV410-191P		
		Adult Soft	EV410S-191P		
		Pediatric Clip	EV110-191P		
		Pediatric Soft	EV110S-191P		
		Neonate Wrap	EV310-191P		
		Multi-Site	EV810-191P		
Digital Tech Sensors; Contec; Promed PM7000; Sinohero S80; Risingmed RPM9000C DIGITAL TECHNOLOGY	 5 PIN 1 BIT REDEL	Adult Clip	EV410-46D		ES0170B-L
		Adult Soft	EV410S-46D		ES0170D-L
		Pediatric Clip	EV110-46D		ES0170C-L
		Pediatric Soft	EV110S-46D		ES0170E-L
		Neonate Wrap	EV310-46D		ES0170I-L
		Multi-Site	EV810-46D		ES0170G-L
EDAN Oximetry M3, M3A, M3B, M8, M8A, M8B, M9, M9A, M50, M80, iM8, iM8A, iM8B, iM9, iM9A, iM50, iM80 (*Non-Oximax)	 5PIN 2 BIT 40DEG REDEL	Adult Clip	EV410-29		ES0016B-L
		Adult Soft	EV410S-29		ES0016D-L
		Pediatric Clip	EV110-29		ES0016C-L
		Pediatric Soft	EV110S-29		ES0016E-L
		Neonate Wrap	EV310-29		ES0016I-L
		Multi-Site	EV810-29		ES0016G-L

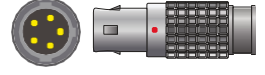

Edan Adapter Cables

Models	Connector	Options	Unimed-EVO	ORIGINAL	EVOTEC OEM
M3, M3B, M8, M8A, M8B, M9, M9A, M50, M80, iM9, iM9A, iM50, iM80 with Oximax technology	To Monitor:  To Nellcor Oximax Sensor: 	2.2m Adapter	EV708P-191		

Goldway Direct Connect Sensors

Models	Connector	Options	Unimed-EVO	ORIGINAL	EVOTEC OEM
UT4000A, UT4000F, UT4000; Choice Electronics MMED6000DP	 5PIN 1 BIT REDEL	Adult Clip	EV410-37		ES0007B-L
		Adult Soft	EV410S-37		ES0007D-L
		Pediatric Clip	EV110-37		ES0007C-L
		Pediatric Soft	EV110S-37		ES0007E-L
		Neonate Wrap	EV310-37		ES0007I-L
		Multi-Site	EV810-37		ES0007G-L
Goldway monitors and DRE Spectra AG5	 7 PIN 1 BIT REDEL	Adult Clip	EV410-38		ES0060B-L
		Adult Soft	EV410S-38		ES0060D-L
		Pediatric Clip			ES0060C-L
		Pediatric Soft			ES0060E-L
		Neonatal Wrap			ES0060I-L
		Multi-Site			ES0060G-L
4000B	 5 PIN LEMO	Adult Clip	EV410-11		ES0038B-L
		Adult Soft	EV410S-11		ES0038D-L
		Pediatric Clip	EV110-11		ES0038C-L
		Pediatric Soft	EV110S-11		ES0038E-L
		Neonate Wrap	EV310-11		ES0038I-L
		Multi-Site	EV810-11		ES0038G-L
3100	 5 PIN 80 DEG 2 SLOT	Adult Clip	EV410-61D		ES0084B-L
		Adult Soft	EV410S-61D		ES0084D-L
		Pediatric Clip	EV110-61D		ES0084C-L
		Pediatric Soft	EV110S-61D		ES0084E-L
		Neonatal Wrap	EV310-61D		ES0084I-L
		Muti-Site	EV810-61D		ES0084G-L

Goldway Adapter Cables

Models	Connector	Options	Unimed-EVO	ORIGINAL	EVOTEC OEM
UT4000C, UT4000E, UT4000Apro, UT4000Fpro, UT6000A	To Monitor:  To Nellcor non-Oximax Sensor: 	2.2 m Adapter	EV708-11		ES708-11

Guoteng Direct Connect Sensors

Models	Connector	Options	Unimed-EVO	ORIGINAL	EVOTEC OEM
GT3000,GT5000, GT6000GT7000, GT9000,GT9002	 6 PIN 1 BIT REDEL	Adult Clip	EV410-179	608010	ES0024B-L
		Adult Soft	EV410S-179		ES0024D-L
		Pediatric Clip			ES0024C-L
		Pediatric Soft			ES0024E-L
		Neonate Wrap			ES0024I-L
		Multi-Site	EV810-179		ES0024G-L

Hwatime Direct Connect Sensors

Models	Connector	Options	Unimed-EVO	ORIGINAL	EVOTEC OEM
H5A, H5B, H5C,H5E,H5G, H5H, H6 , H8, H9	 6 PIN 2BIT 40DEG REDEL	Adult Clip		608010	ES0077B-L
		Adult Soft			ES0077D-L
		Pediatric Clip			ES0077C-L
		Pediatric Soft			ES0077E-L
		Neonate Wrap			ES0077I-L
		Multi-Site			ES0077G-L
HT6, HT8, HT9		Adult Clip			ES0078B-L
		Adult Soft			ES0078D-L
		Pediatric Clip			ES0078C-L
		Pediatric Soft			ES0078E-L
		Neonatal Wrap			ES0078I-L
		Multi - Site			ES0078G-L

Marquette (GE) See also Datex Ohmeda GE health

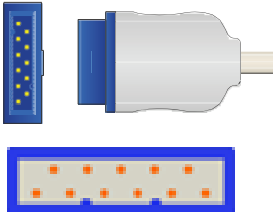
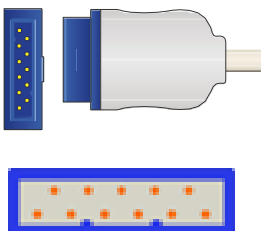
Models	Connector	Options	Unimed-EVO	ORIGINAL OEM #	EVOTEC OEM
Eagle, Dash, Solar Series, GE Responder 2000, Responder 3000 and Series Tram Modular x50SL with Nellcor technology		Adult Clip	EV410-21	407705-006	ES0002B-L
		Adult Soft	EV410S-21		ES0002D-L
		Pediatric Clip	EV110-21		ES0002C-L
		Pediatric Soft	EV110S-21		ES0002E-L
		Neonate Wrap	EV310-21		ES0002I-L
		Multi-Site	EV810-21		ES0002G-L
Corometrics 250cx and Marquette monitors with Oximax technology		Adult Clip	EV410-21P	2025350-001, 2021406-001	ES0122B-L
		Adult Soft	EV410S-21P		ES0122D-L
		Pediatric Clip	EV110-21P		ES0122C-L
		Pediatric Soft	EV110S-21P		ES0122E-L
		Neonate Wrap	EV310-21P		ES0122I-L
		Multi-Site	EV810-21P		ES0122G-L

Marquette (GE) Direct Connect Sensors

Models	Connector	Options	Unimed-EVO	ORIGINAL	EVOTEC OEM
Dash 2000, 3000, 4000, 5000, i/9500 (Tram 451N5/851N5). Solar 7000, 8000 e Eagle 1000, 3000, Smk SMV, Corometrics 250 with Masimo technology		Adult Clip	EV410-21M	TS-F2-GE, TS-F4-GE	ES0025B-L
		Adult Soft	EV410S-21M	TS-SA4-GE	ES0025D-L
		Pediatric Clip	EV110-21M		ES0025C-L
		Pediatric Soft	EV110S-21M		ES00258E-L
		Neonate Wrap	EV310-21M		ES0025I-L
		Multi-Site	EV810-21M		ES0025G-L

Marquette (GE) Direct Connect Sensors



Models	Connector	Options	Unimed-EVO	ORIGINAL	EVOTEC OEM
GE S/5 (i4 E series module built in) TRUSIGNAL		Adult Clip	EV410-21M	TS-F2-GE, TS-F4-GE	ES0128B-L
		Adult Soft	EV410S-21M	TS-SA4-GE	ES0128D-L
		Pediatric Clip	EV110-21M		ES0128C-L
		Pediatric Soft	EV110S-21M		ES0128E-L
		Neonate Wrap	EV310-21M		ES0128I-L
		Multi-Site	EV810-21M		ES0128G-L



Marquette (GE) Adapter Cables

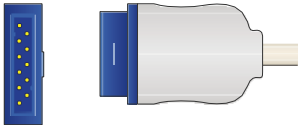
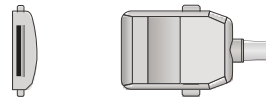

Models	Connector	Options	Unimed-EVO	ORIGINAL	EVOTEC OEM
Eagle, Dash, SOLAR, TRAM Modular and x50SL Series, GE Carescape Dinamap V100 with Nellcor technology, Corometrics TRAM 450SL, Corometrics 0128 without Oximax technology	To Monitor: To Nellcor non-Oximax Sensor: 	2.2 m Adapter	EV708-21	2006644-001, 407252-002, E9004DE, TE2423, CB-A400- 1102A	ES0002OX-L
For use on monitors with the Oximax SpO2 module for use with non Oximax sensors	To Monitor: To Nellcor non-Oximax Sensor: 	2.2m Adapter	EV708-21P		
GE Carescape Dinamap V100, Dash 3000, Dash 4000, Dash 5000, Solar 8000, Solar 8000M, i9500 with Tram module 451N5/851N5, GE 250CX, Corometrics 250, GE Corometrics 259 Fetal Monitor With technology Oximax	To Monitor: To Nellcor Oximax Sensor: 	2.2m Adapter	EV710P-21	2021406-001, 2025350-001, 20221406-001	ES0122OX-L

Marquette GE Adapter Cables (Continued)

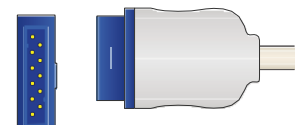
Models	Connector	Options	Unimed-EVO	ORIGINAL	EVOTEC OEM
Dash, Solar, Careescape DinamapV100 with Masimo technology	To Monitor:  To Nellcor non-Oximax Sensor: 	2.2 m Adapter	EV708-21M		ES0025CS-L

Models	Connector	Options	Unimed-EVO	ORIGINAL	EVOTEC OEM
Corometrics 250, Corometrics 259, Dash Masimo option, Solar i/9500 with Tram Module 451M/851M, 451M, Datex Ohmeda Giraffe Warmer	To Monitor:  	2.2 M Adapter	EV708M-21P	2017002-00, 2017002-001, 2016041-01, 2016041-PC-12-GE 1890	ES0025MA-L

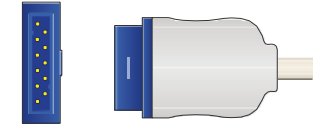
Models	Connector	Options	Unimed-EVO	ORIGINAL	EVOTEC OEM
Dash, Solar, Careescape DinamapV100 with Masimo technology	To Monitor:  To Masimo LNCS Sensor: 	2.2M Adapter	EV708M-21	LNC-10-GE 2016, 2027263-002, PS-10153D	XXX

Models	Connector	Options	Unimed-EVO	ORIGINAL	EVOTEC OEM
CARESCAPE* modular monitors and S/5, AS/3 and CS/3 modular monitors with E-(P)RESTN or E- PSM(P) modules. CARESCAPE V100 with TruSignal* option, Responder, B20 and B30 monitors TRUSIGNAL	 	2.2m Adaptor	EV708-111	TS-G3	ES0190TS-L

Masimo Direct Connect Sensors

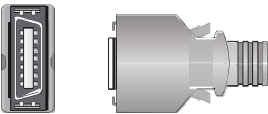
Models	Connector	Options	Unimed-EVO	ORIGINAL	EVOTEC OEM
All Massimo		Adult Clip	EV402-15	DC-8 2387, 2027277-001, 01-02-0730, 01-02-	ES0020B-L
		Adult Soft	EV402S-15	DBI-DC8 2653	ES0020D-L
		Pediatric Clip	EV110-15		ES0020C-L
		Pediatric Soft	EV110S-15		ES0020E-L
		Neonate Wrap	EV310-15		ES0020I-L
		Multi-Site	EV810-15		ES0020G-L

Masimo Short Sensors



Models	Connector	Options	Unimed-EVO	ORIGINAL	EVOTEC OEM
Masimo LNOP Sensor		Adult Clip	EV403-125	1269 LNOP DCI, 0600-00-0047, 7270312, 2002800-001,	ES0125B-L
		Adult Soft	EV403S-125		ES0125D-L
		Pediatric Clip	EV103-125	1276 LNOP DCIP, 0600-00-0063, 7270304, 2002799-001,	ES0125C-L
		Pediatric Soft	EV103S-125		ES0125E-L
		Neonate Wrap	EV303-125		ES0125I-L
		Adult Ear Clip	EV903-125	2027274-001, 9898031 40341	ES0125I-L+CLIP
		Multi-Site	EV803-125	1544 LNOP YI, 0600-00-0078, 7497014, 2010463-001, 690-0232-00	ES0125G-L

Models	Connector	Options	Unimed-EVO	ORIGINAL	EVOTEC OEM
Masimo LNCS Sensor		Adult Clip	EV403-49	1863 LNCS DCI, 0010-10-42600, 0600-00-0126, MP00796, 9898031 48281,	ES0049B-L
		Adult Soft	EV403S-49	2653 LNCS DBI	ES0049D-L
		Pediatric Clip	EV103-49	1864 LNCS DCIP, 01-02-0906, 0010-10-42634, 0600-00-0127,	ES0049C-L
		Pediatric Soft	EV103S-49		ES0049E-L
		Neonate Wrap	EV303-49		ES0049I-L
		Adult Ear Clip	EV903-49	1895 LNCS TC-I, 2027261-001,	ES0049G-L+CLIP
		Multi-Site	EV803-49	2258 LNCS YI, MP00789	ES0049G-L







Masimo Disposable Sensors

Models	Connector	Options	Unimed-EVO	ORIGINAL	EVOTEC OEM
LNOP disposable sensor		Adult Box of 24	EV503-125	LNOP Adtx	ES0125J-S
		Pediatric Box of 24	EV523-125	LNOP Pdtx	ES0125K-S
		Infant Box of 24	EV533-125	LNOP INF	ES0125L-S
		Neonate Box of 24	EV543-125	LNOP Neo	ES0125M-S
		Adult Box of 24	EV503-49	1859 LNCS Adtx, 2027253-001	ES0049J-S
		Pediatric Box of 24	EV523-49	1860 LNCS Pdtx, 2027254-001	ES0049K-S
		Infant Box of 24	EV33-49	2328 LNCS INF, 2027255-001, 1777, 2319	ES0049L-S
		Neonate Box of 24	EV43-49	2329 LNCS Neo, 2027256-001,	ES0049M-S

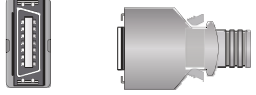
Masimo Adapter Cables

Models	Connector	Options	Unimed-EVO	ORIGINAL	EVOTEC OEM
All Masimo; MDE: Escort II OPT30; Prism; GE Marquette: Pro1000, V300; Invivo: T8; Schiller; Zoll; Datascope: Trio, Passport 2, Spectrum	To Monitor:  To Masimo LNCS Sensor: 	2.2 M Adapter	EV708M-49	LNC MAC-180, 2268, 8000-0325	ES0049OX-L

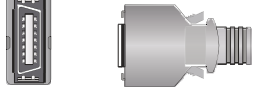
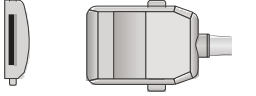
Masimo Adapter Cables

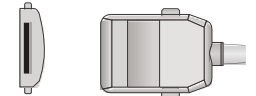
Models	Connector	Options	Unimed-EVO	ORIGINA	EVOTEC OEM
Masimo adapter cable for use with Nellcor non-Oximax sensors	To Monitor:  To Nellcor non-Oximax Sensor: 	2.2M Adapter	EV708-15		SEE UNIMED/EVO Or ONE PIECE
Datascope Accutorr V, Duo, Passport 2, Passport 2LT, Passport V, Spectrum, Spectrum OR, Trio, V12, V21; Medtronic Physio Control: Lifepak 11, Lifepak 12, Lifepak 15, Lifepak 20; Welch Allyn: Spot Vital Signs 42MTB-E1, 45NE0-E1 LX; Zoll: E Series, M Series, R Series	To Monitor:  To Masimo LNCS Sensor: 	30CM Adapter	EV701M-15	LNC-1 2364	SEE UNIMED/EVO
		1M Adapter	EV704M-15	LNC-4 2017, 01-02-0903	SEE UNIMED/EVO
		2.2M Adapter	EV708M-15	0012-00-1652, 0012-00-1653,	SEE UNIMED/EVO
		3M Adapter	EV710M-15	LNC-10 1814, 01-02-0904	SEE UNIMED/EVO
Equipment that require LNOP-type sensors including the Atom V-2100G incubator	To Monitor:  To Masimo LNOP Sensor: 	30CM Adapter	EV704M-15P	PC04 1173	SEE UNIMED/EVO
		2.5m Adapter	EV708M-15P	PC08 1005, 0012-00-1099-01, 0012-00-1099-02, 2009743-	SEE UNIMED/EVO
		3m Adapter	EV711M-15P	PC12 1006	SEE UNIMED/EVO
Datascope: Accutorr V, Duo, Passport 2, Passport V, Spectrum, Spectrum OR, Trio, V12, V21	To Monitor:  To Masimo LNOP Sensor: 	1m Adapter	EV704M-49P	MAC-1 1927, 0012-00-1656	SEE UNIMED/EVO

Meditech Direct Connect Sensors

Models	Connector	Options	Unimed-EVO	ORIGINAL	EVOTEC OEM
G3D, G3C, G3F, G3H, G3L		Adult Clip	EV410-65D		
		Adult Soft	EV410S-65D		
		Pediatric Clip	EV110-65D		
		Pediatric Soft	EV110S-65D		
		Neonate Wrap	EV310-65D		
		Multi-Site	EV810-65D		

Medtronic (physio control) Direct Connect Sensors

Models	Connector	Options	Unimed-EVO	ORIGINAL	EVOTEC OEM
Lifepack 12 NON OXIMAX		Adult Clip			ES0010B-L
		Adult Soft			ES0010D-L
		Pediatric Clip			ES0010C-L
		Pediatric Soft			ES0010E-L
		Neonate Wrap			ES0010I-L
		Multi-Site			ES0010G-L
LIFEPAK 12, 20		Adult Clip	EV410-15		ES0020B-L
		Adult Soft	EV410S-15		ES0020D-L
		Pediatric Clip			ES0020C-L
		Pediatric Soft			ES0020E-L
		Neonatal Wrap	EV810-15		ES0020I-L
		Multi-Site			ES0020G-L

Mindray Direct Connect Sensors

Models	Connector	Options	Unimed-EVO	ORIGINAL	EVOTEC OEM
PM 600, PM 6000 (New), PM 7000, 6201, PM 8000, PM 9000, PM 9000 Express, MEC 100, MEC 200, MEC 1000, MEC 1200, 809B, VS 800; Mennen Enmove 1000, Mercury; Kontron: 7138, 7840, 7845; Medec: MEDEC-1000, M-1000, M-1100; Creative: PC9000, UP6000; Edan: M3, M3A, M3B, M8, M8A, M8B, M9, M9A, M50, M80, iM8, iM8A, iM8B, iM9, iM9A, iM50, iM80; Goldway, Contec and Danatech, Penlon Intermed PM 8000	 6 PIN 2 BIT 40 DEG REDEL	Adult Clip	EV410-29		ES0016B-L
		Adult Soft	EV410S-29		ES0016D-L
		Pediatric Clip	EV110-29		ES0016-C-L
		Pediatric Soft	EV110S-29		ES0016E-L
		Neonate Wrap	EV310-29		ES0016I-L
		Multi-Site	EV810-29		ES0016G-L
PM 6000, PM 6201, PM 7000, PM 8000, PM 9000 Express, PM 9000, PM 9100, PM 9200P, M1K0, M2K0 VS800 <i>(before January 2006) with Masimo technology</i>	 6 PIN 2 BIT 80 DEG	Adult Clip	EV410-30M		ES0134B-L
		Adult Soft	EV410S-30M		ES0134D-L
		Pediatric Clip	EV110-30M		ES0134C-L
		Pediatric Soft	EV110S-30M		ES0134E-L
		Neonate Wrap	EV310-30M		ES0134I-L
		Multi-Site	EV810-30M		ES0134G-L

Mindray Direct Connect Sensors (Continued)

Models	Connector	Options	Unimed-EVO	ORIGINAL	EVOTEC OEM
PM 6000 and PM 8000 with <i>Masimo technology</i>	 6PIN 2BIT 40 DEG REDEL	Adult Clip	EV410-29M		ES0116B-L
		Adult Soft	EV410S-29M		ES0116D-L
		Pediatric Clip	EV110-29M		ES0116C-L
		Pediatric Soft	EV110S-29M		ES0116E-L
		Neonate Wrap	EV310-29M		ES0116I-L
		Multi-Site	EV810-29M		ES0116G-L
PM 9000 express <i>Oximax technology</i>	 6PIN 2BIT 80 DEG	Adult Clip	EV410-180P		ES0129B-L
		Adult Soft	EV410S-180P		ES0129D-L
		Pediatric Clip			ES0129C-L
		Pediatric Soft			ES0129E-L
		Neonate Wrap			ES0129I-L
		Multi-Site	EV810-180P		ES0129G-L
503, 507, 508, 509, Mindray PM 9000 with <i>Criticare technology</i>	 5 PIN LEMO	Adult Clip	EV410-31		ES0053B-L
		Adult Soft	EV410S-31		ES0053D-L
		Pediatric Clip	EV110-31		ES0053C-L
		Pediatric Soft	EV110S-31		ES0053E-L
		Neonate Wrap	EV310-31		ES0053I-L
		Multi-Site	EV810-31		ES0053G-L
PM 5000, PM 6000, PM 8000 <i>BCI MODULE</i>		Adult Clip	EV410-22		ES0045B-L
		Adult Soft	EV410S-22		ES0045D-L
		Pediatric Clip	EV110-22		ES0045C-L
		Pediatric Soft	EV110S-22		ES0045E-L
		Neonate Wrap	EV310-22		ES0045I-L
		Multi-Site	EV810-22		ES0045G-L
PM 6000 with <i>Masimo technology</i>		Adult Clip	EV410-22M		ES0012B-L
		Adult Soft	EV410S-22M		ES0012D-L
		Pediatric Clip	EV110-22M		ES0012C-L
		Pediatric Soft	EV110S-22M		ES0012E-L
		Neonate Wrap	EV310-22M		ES0012I-L
		Multi-Site	EV810-22M		ES0012G-L
BeneView T5, T8 and iPM-8900 <i>Mindray / Nellcor Technology</i>		Adult Clip	EV410-48		ES0136B-L
		Adult Soft	EV410S-48		ES0136D-L
		Pediatric Clip	EV110-48		ES0136C-L
		Pediatric Soft	EV110S-48		ES0136E-S
		Neonate Wrap	EV310-48		ES0136I-L
		Multi-Site	EV810-48		ES0136G-L

Mindray Direct Connect Sensors (Continued)

Models	Connector	Options	Unimed-EVO	ORIGINAL	EVOTEC OEM
Beneview T5/ T8 <i>Oximax technology</i>		Adult Clip			ES0135B-L
		Adult Soft			ES0135D-L
		Pediatric Clip			ES0135C-L
		Pediatric Soft			ES0135E-L
		Neonate Wrap			ES0135I-L
		Multi-Site			ES0135G-L
Beneview T5 / T8 <i>Massimo technology M-Tech</i>		Adult Clip			ES0133B-L
		Adult Soft			ES0133D-L
		Pediatric Clip			ES0133C-L
		Pediatric Soft			ES0133E-L
		Neonatal Wrap			ES0133I-L
		Multi - Site			ES0133G-L

Mindray Adapter Cables



Models	Connector	Options	Unimed-EVO	ORIGINAL	EVOTEC OEM
MEC 100, MEC 200, PM 7000, 6201, PM 8000, PM 9000, VS-800, Datascope Trio, Accutorr V, Passport V <i>Mindray / Nellcor technology</i>	To Monitor: To Nellcor non-Oximax Sensor: 	2.2m Adapter	EV708-29	0010-20-42594	ES0040NE-L

Models	Connector	Options	Unimed-EVO	ORIGINAL	EVOTEC OEM
Trio, Mindray PM 7000, PM 9000 PM9000 express VS800 NEW PM 6000 <i>Nellcor Oximax</i>	To Monitor: To Nellcor Oximax Sensor: 	3m Adapter	EV710P-180		ES0129NE-L
VS 800, PM 7000, PM 8000, PM 9000 Series and New PM 6000 with <i>Masimo technology</i>	To Monitor: To Massimo LNOP Sensor 	2.2m Adaptor	EV708M-29P	9200-30-10707	ES0013MA-L

Mindray Adapter Cables (Continued)

Models	Connector	Options	Unimed-EVO	ORIGINAL	EVOTEC OEM
VS 800, PM 7000, PM 8000, PM 9000 Series and New PM 6000.	<p>To Monitor:</p>  <p>To Masimo LNCS Sensor:</p> 	2.2m Adapter	EV708M-30	0010-30-42625, 9200-30-10682	ES708M-30
PM 5000, PM 6000, PM 8100	<p>To Monitor:</p>  <p>To Nellcor non-Oximax Sensor:</p> 	2.2M Adapter	EV708-22	0010-30-42737, 0010-20-42710	ES0045OX-L
PM 6000 with Masimo technology	<p>To Monitor:</p>  <p>To Masimo LNCS Sensor:</p> 	2.2M Adapter	EV708M-22	0010-30-12452	ES708M-22
BeneView T5, T8, PM 6800 without Oximax and Penlon Intermed Patient Monitors	<p>To Monitor:</p>  <p>To Nellcor non-Oximax</p> 	2.2M ADAPTOR	EV708-48	0010-20-42710	ES0125CO-L
BeneView T5 and T8 with Oximax technology	<p>To Monitor:</p>  <p>To Nellcor Oximax Sensor</p> 	2.2M ADAPTOR	EV710P-48	0010-20-42712	ES0126OX-L

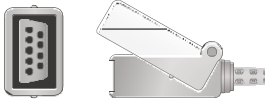

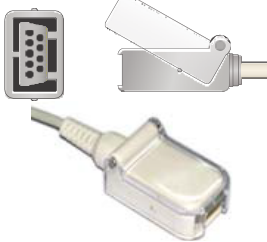
Mindray Adapter Cables (Continued)

Models	Connector	Options	Unimed-EVO	ORIGINAL	EVOTEC OEM
T5, T8 and Penlon Intermed patient monitors with OXIMAX technology	To Monitor:  To Nellcor non-Oximax Sensor: 	2.2M Adapter	EV708-48M	0010-30-42738	ES0126CO-L
BeneView T5 and T8 MASSIMO / M-TECH	To Monitor:  To Masimo LNCS Sensor: 	2.2M Adapter	EV708M-48	0010-30-42738	ES708M-48 ES0126CL-S USE ES0153B-S

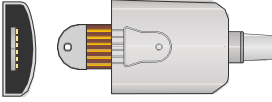
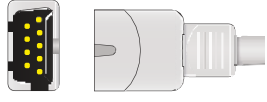

Mindray Disposable Sensors

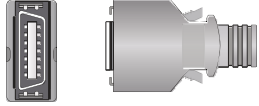
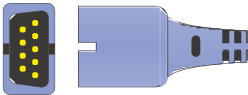
Models	Connector	Options	Unimed-EVO	ORIGINAL	EVOTEC OEM
LNOP disposable sensor		Adult Box of 24	EV503-125	LNOP Adtx	ES0125J-S
		Pediatric Box of 24	EV523-125	LNOP Pdtx	ES0125K-S
		Infant Box of 24	EV533-125	LNOP INF	ES0125L-S
		Neonate Box of 24	EV543-125	LNOP Neo	ES0125M-S
		Adult Box of 24	EV503-49	1859 LNCS Adtx, 2027253-001	ES0153J-S
		Pediatric Box of 24	EV523-49	1860 LNCS Pdtx, 2027254-001	ES0153K-S
		Infant Box of 24	EV33-49	2328 LNCS INF, 2027255-001, 1777, 2319	ES0153L-L
		Neonate Box of 24	EV43-49	2329 LNCS Neo, 2027256-001,	ES0153M-L
		Comfort Box of 24			ES0153N-L

Nellcor Direct Connect Sensors

Models	Connector	Options	Unimed-EVO	ORIGINAL	EVOTEC OEM
Datascope: Accutorr Plus (Nellcor); Invivo: MDE Prism Escort; Nellcor: NPB 290, NPB 295, N 390, N 395, N 3000, N 6000; Nihon Kohden: BSM-4104A, BSM-4114A and Colin Press Mate, Prodigy, BP88/306, BP885 NON OXIMAX	TO MONITOR: 	Adult Clip	EV410-69		ES0001B-L
		Adult Soft	EV410S-69		ES0001D-L
		Pediatric Clip	EV110-69		ES0001C-L
		Pediatric Soft	EV110S-69		ES0001E-L
		Neonate Wrap	EV310-69		ES0001I-L
		Multi-Site	EV810-69		ES0001G-L
OXIMAX – ALL UNITS 3 METER LENGTH	TO MONITOR: 	Adult Clip			ES0132B-L
		Adult Soft			ES0132D-L
		Pediatric Clip			ES0132C-L
		Pediatric Soft			ES0132E-L
		Neonate Wrap			ES0132I-L
		Multi-Site			ES0132G-L
OXI – TECH DOC10 (COMPLETE) 3 METER		Adult Clip			ES0117B-L
		Adult Soft			ES0117D-L
		Pediatric Clip			ES0117C-L
		Pediatric Soft			ES0117E-L
		Neonatal Clip			ES0117I-L
		Multi - Site			ES0117G-L

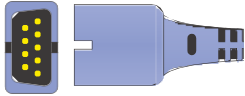
Nellcor Short Sensors

Models	Connector	Options	Unimed-EVO	ORIGINAL/ORIGINA	EVOTEC OEM
All monitors with Nellcor Oximax SpO2 technology OXIMAX -ALL		Adult Clip	EV403-01P	DS100A	ES0132B-S
		Adult Soft	EV403S-01P	OXI-A/N	ES0132D-S
		Pediatric Clip	EV103-01P	OXI-P/I	ES0132C-S
		Pediatric Soft	EV103S-01P		ES0132E-S
		Neonate Wrap	EV303-01P		ES0132I-S
		Adult Ear Clip	EV903-01P		ES0132G-S+CLIP
		Multi-Site	EV803-01P	D-YS	ES0132G-S
OXIMAX High Copy & Original		Adult Clip	High Copy	DS100A	DS100A-C
		Adult Clip	Original	DS100A	DS100A

Nellcor Disposable Sensors

Models	Connector	Options	Unimed-EVO	ORIGINAL	EVOTEC OEM
All monitors with Nellcor Oximax technology		Adult Box of 24	EV503-01P	MAX-A, 70124027, MX50065	ES0026J-S
		Pediatric Box of 24	EV523-01P	MAX-P, 70124022, MX50066	ES0026K-S
		Infant Box of 24	EV533-01P	MAX-I, 70124026, MX50067	ES0026L-L
		Neonate Box of 24	EV543-01P	MAX-N, 70124032, MX50068	ES0026M-L



Nellcor Disposable Sensors (Continued)

Models	Connector	Options	Unimed-EVO	ORIGINAL	EVOTEC OEM
All monitors with Nellcor Oximax technology ORIGINAL		Adult Box of 24	EV503-01	D25, 2023217-001, M1131A	MAX-A
		Pediatric Box of 24	EV523-01	D20	MAX-P
		Infant Box of 24	EV533-01	I20, M1132A	MAX-I
		Neonate Box of 24	EV543-01	N25, 2023216-001, M1133A, M1134A	MAX-N

Nellcor Adapter Cables

Models	Connector	Options	Unimed-EVO	ORIGINAL	EVOTEC OEM
Colin: BP88/306; Critikon Dinamap ProCare, Pro Series, Pro 300, Pro 1000, M-NSAT Modules; Datascope: Accutorr Plus, Duo, Passport 2, Passport XG, Spectrum, Trio; Nellcor: NPB-290, NPB-295, N-390, N-395, N-3000, N-6000, NPB-290, NPB-295, N-390, N-395, N-3000, N-6000; Nihon Kohden: BSM-2300, BSM-4100, BSM-5100, BSM-4104A, BSM-4114A; Ohmeda enGuard CM5; Physio Control Lifepak 12	To Monitor: To Nellcor non-Oximax Sensor: 	2.2M Adapter	EV708-69	SCP-10, MC-10, 200012-00-1254, NK-SCP-10, 0012-00-1254, 903131	ES0001NE-L
NBP-195; Colin; GE Dinamap Compact Dinamap MPS; All Welch Allyn	To Monitor: To Nellcor Oximax Sensor: 	1m Adapter	EV704-71	DEC-04	ES0026OX-S
		2.2M Adapter	EV708-71	DEC-08, NON-UNI-EXT-3, EC8	ES0026OX-L
		3M Adapter	EV710-71	DEC-10	
N-595 and N-600; CAS Med 511 Apnea Monitor; Cardell Veterinary 9403, 9500HD; Colin BP-S510 and T105NXM; Digicare LW600; Dinamap Carescape V100, ProCare, Pro Series, ProSeries V2, Pro 300, Pro 1000, Pro 1000 V3, E-NSAT Modules for i4 Modular Monitors with Oximax option; Fukuda Denshi DS-7100; GE Procure; Welch Allyn Spot Vital Signs 42NTB-E1, 42NT0-E1 LXI	To Monitor: To Nellcor Oximax Sensor: 	3M Adapter	EV710-70	DOC-10 , WA-DOC-10, 0012-00-1464, 01-02-0183, 2008773-001, 2021406-002	ES0117OX-L

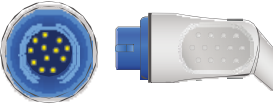
Newtech / Solaris Direct Connect Sensors

Models	Connector	Options	Unimed-EVO	ORIGINAL	EVOTEC OEM
NT3A		Adult Clip	EV410-173D		ES0141B-L
		Adult Soft	EV410S-173D		ES0141D-L
		Pediatric Clip	EV110-173D		ES0141C-L
		Pediatric Soft	EV110S-173D		ES0141E-L
		Neonate Wrap	EV310-173D		ES0141I-L
		Multi-Site	EV810-173D		ES0141G-L
NT2A DIGITAL TECHNOLOGY		Adult Clip	EV410-165D		ES0140B-L
		Adult Soft	EV410S-165D		ES0140D-L
		Pediatric Clip	EV110-165D		ES0140C-L
		Pediatric Soft	EV110S-165D		ES0140E-L
		Neonate Wrap	EV310-165D		ES0140I-L
		Multi-Site	EV810-165D		ES0140G-L

Nihon Kohden Direct Connect Sensors

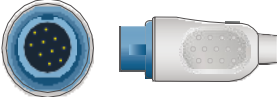
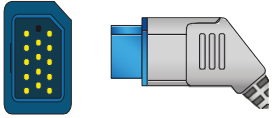
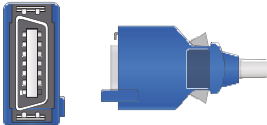
Models	Connector	Options	Unimed-EVO	ORIGINAL	EVOTEC OEM
AL-800PA Module, BSM-1101 Life Scope EC, BSM-2101/2 Life Scope LC, BSM-7100/7200 Life 8, BSM-8200/1 Life Scope 12, Life Scope 9, SM-8800 Life Scope OLV-1100A, NT3B		Adult Clip	EV410-16		ES0069B-L
		Adult Soft	EV410S-16		ES0069D-L
		Pediatric Clip	EV110-16		ES0069C-L
		Pediatric Soft	EV110S-16		ES0069E-L
		Neonate Wrap	EV310-16		ES0069I-L
		Multi-Site	EV810-16		ES0069G-L
BSM-4101, BSM-4102, BSM- 4102A, 4103, 4111, 4113 Life Scope P, BSM-5105,5135 Life Scope A, BSM-2351, 2353 Life Scope L, BSM-2301, 2303 Life Scope I, Life Scope J, BSM-9101 and PVM-2701		Adult Clip	EV410-36	TL-201T	ES0005B-L
		Adult Soft	EV410S-36		ES0005D-L
		Pediatric Clip	EV110-36		ES0005C-L
		Pediatric Soft	EV110S-36		ES0005E-L
		Neonate Wrap	EV310-36		ES0005I-L
		Multi-Site	EV810-36		ES0005G-L
OPV-1500		Adult Clip	EV410-106		ES0159B-L
		Adult Soft	EV410S-106		ES0159D-L
		Pediatric Clip	EV110-106		ES0159C-L
		Pediatric Soft	E110S-106		ES0159E-L
		Neonate Wrap	EV310-106		ES0159I-L
		Multi-Site	EV810-106		ES0159G-L

Nihon Kohden Short Sensors

Models	Connector	Options	Unimed-EVO	ORIGINAL	EVOTEC OEM
BSM-2300 Life Scope I, BSM-2301, MSM 2301K, 2303 Life Scope I, 2303K, BSM2350 Life Scope L, BSM-2351, 2353 Life Scope L, BSM-4100 Life Scope P, BSM 4101, 4103 TL-101T, 4111, 4113 Life Scope P, BSM-5100 Life Scope A, BSM-5105, 5135 Life Scope A, Life Scope TR, BSM-6000 series, BSM-6301K, BSM-6501K, BSM-6701K, BSM-9510 Life Scope M, BSM-9800 Life Scope S, Oxipal P225F		Adult Clip	EV405-16	TL-101T, TL-201T	ES0005B-S
		Adult Soft	EV405S-16		ES0005D-S
		Pediatric Clip	EV105-16		ES0005C-S
		Pediatric Soft	EV105S-16		ES0005E-S
		Neonate Wrap	EV305-16		ES0005I-S
		Multi-Site	EV805-16	TL-220T, TL-260T	ES0005G-S



Nihon Kohden Disposable Sensors

Models	Connector	Options	Unimed-EVO	ORIGINAL	EVOTEC OEM
		Adult Box of 24	EV503-16	TL-251T, TL-271T3	ES0005J-S
		Pediatric Box of 24	EV523-16	TL-252T, TL-272T3	ES0005K-S
		Infant Box of 24	EV533-16	TL-252T	ES0005L-L
		Neonate Box of 24	EV543-16	TL-253T, TL-273T3	ES0005M-L
		Comfort Box of 24			ES0005N-L



Nihon Kohden Adapter Cables

Models	Connector	Options	Unimed-EVO	ORIGINAL	EVOTEC OEM
BSM-2300 Life Scope I, BSM-2301A, BSM-2351, 2353 Life Scope L, BSM-2301, 2303 Life Scope I, BSM-4100 Life Scope P, BSM-4101, 4103, 4111, 4113 Life Scope P, BSM-5100 Life Scope A, BSM-5105, 5135 Life Scope A, Life Scope TR, BSM- 6000 series, BSM-6301K, BSM-6501K, BSM-6701K, BSM-9510 Life Scope M, BSM-9800 Life Scope S	To Monitor: 	2.2m Adapter	EV710-36	JL-900P	ES0005NI-L
To Nihon Kohden Sensor: 					
BSM-6313, BSM-6333, BSM-6533, BSM- 6573, BSM-6733, BSM-6773, BSM-9173	To Monitor: 	2.2m Adapter	EV710M-36	JL-631P	ES710M-36
To Masimo LNCS Sensor: 					
Life Scope TR, BSM-6000 series, BSM- 6310K, BSM-6501K, BSM-6701K and AY-651P and AY-653P modules	To Monitor: 	2.2M Adapter	EV710P-36	JL-650P	ES0005OX-L
To Nellcor Oximax Sensor: 					

Nihon Kohden Adapter Cables (Continued)

Models	Connector	Options	Unimed-EVO	ORIGINAL OEM #	EVOTEC OEM
OPV-1500 Life Scope N	<p>To Monitor:</p>  <p>To Nihon Kohden Sensor:</p> 	3m Adapter	EV710-106	JL-302T	ES0159NI-L

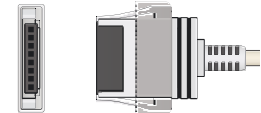
Nonin Direct Connect Sensors

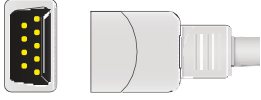
Models	Connector	Options	Unimed-EVO	ORIGINAL	EVOTEC OEM
Es109b-l		Adult Clip	EV410-28		ES0109B-L
		Adult Soft	EV410S-28		ES0109D-L
		Pediatric Clip	EV110-28		ES0108C-L
		Pediatric Soft	EV110S-28		ES0109E-L
		Neonate Wrap	EV310-28		ES0109I-L
		Multi-Site	EV810-28		ES0109G-L
8604, 86es109d-l04D		Adult Clip	EV410-08		ES0106B-L
		Adult Soft	EV410S-08		ES0106D-L
		Pediatric Clip	EV110-08		ES0106C-L
		Pediatric Soft	EV110S-08		ES0106E-L
		Neonate Wrap	EV310-08		ES0106I-L
		Multi-Site	EV810-08		ES0106G-L
8000 J-3es109		Adult Clip	EV410-08L		ES0080B-L
		Adult Soft	EV10S-08L		ES0080D-L
		Pediatric Clip	EV110-08L		ES0080C-L
		Pediatric Soft	EV110S-08L		ES0080E-L
		Neonate Wrap	EV310-08L		ES0080I-L
		Multi-Site	EV810-08L		ES0080G-L

Nonin Short Sensors

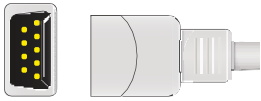
Models	Connector	Options	Unimed-EVO	ORIGINAL OEM #	EVOTEC OEM
2500, 2500A, 2120, 7500, 8500, 8550, 8600, 8700, 8800, 9600, 9700, 9840, Respironics 902M Plus, Lifesense and PureSAT		Adult Clip	EV403-08	8000AA, 8000AA-2, 8000AA-3,	ES0080B-S
		Adult Soft (Large)	EV403S-08	8000SL	ES0080D-S
		Pediatric Clip	EV103-08	8000AP, 01-03-0121, 01-02-	ES0080C-S
		Pediatric Soft (Medium)	EV103S-08	8000SM	ES0080E-S
		Neonate Wrap	EV303-08		ES0080I-S
		Multi-Site	EV803-08		ES0080G-S

Nonin Short Sensors (Continued)

Models	Connector	Options	Unimed-EVO	ORIGINAL OEM #	EVOTEC OEM
Avant 4000 Wearable Digital Pulse Oximetry		Adult Clip	EV401-146	8000AA-WO	ES401-146
		Adult Soft	EV401S-146	8000J-WO	ES401S-146

Nonin Disposable Sensors

Models	Connector	Options	Unimed-EVO	ORIGINAL OEM #	EVOTEC OEM
		Adult Box of 24	EV503-08	6000CA, 7000A	ES0080J-S
		Pediatric Box of 24	EV523-08	6000CP, 7000P	ES0080K-S
		Infant Box of 24	EV533-08	6000CI, 7000I	ES0080L-L
		Neonate Box of 24	EV543-08	6000CN, 7000N	ES0080M-L
		Adult Transpore Box Of 24			ES0080J-SS
		Comfort Box Of 24			ES0080N-L

Nonin Adapter Cables (Also see Nellcor)

Models	Connector	Options	Unimed-EVO	ORIGINAL OEM #	EVOTEC OEM
8604, 8604D	To Monitor: To Nonin Sensor: 	2.2M Adapter	EV708-08		ES0080NE-L

Novametrix Direct Connect Sensors

Models	Connector	Options	Unimed-EVO	ORIGINAL OEM #	EVOTEC OEM
505, 510, 511, 515, 515A, 515B, 515C, Spacelabs: 90351-D/G, 90369, 90466, 90467, 90489, 90651-90419-01, 90651A-07		Adult Clip	EV410-03	369083-001, 8776-00	ES0062B-L
		Adult Soft	EV410S-03		ES0062D-L
		Pediatric Clip	EV110-03		ES0062C-L
		Pediatric Soft	EV110S-03		ES0062E-L
		Neonate Wrap	EV310-03		ES0062I-L
		Multi-Site	EV810-03	8791-00	ES0062G-L



Novametrix Short Sensors

Models	Connector	Options	Unimed-EVO	ORIGINAL OEM #	EVOTEC OEM
505, 510, 511, 512, 513, 515B, 515C, 520, 90351-D/G, 90465, 90466, 90467, 90651-07/08, 90419-01, 90651A-07		Adult clip	EV403-03	8776-00, 9768-00	ES0062B-S
		Adult soft	EV403S-03		ES0062D-S
		Pediatric clip	EV103-03		ES0062C-S
		Pediatric soft	EV103S-03		ES0062E-S
		Neonate Wrap	EV303-03	9168-00	ES0062I-S
		Multi-Site	EV803-03	9769-00	ES0062G-S

Novamatrix Disposable Sensors



Models	Connector	Options	Unimed-EVO	ORIGINAL OEM #	EVOTEC OEM
		Adult Box of 24	EV503-03	AS110	ES0062J-S
		Pediatric Box of 24	EV523-03	AS120	ES0062K-S
		Infant Box of 24	EV533-03	AS120	ES0062I-L
		Neonate Box of 24	EV543-03	AS140	ES0062N-L

Novamatrix Adapter Cables

Models	Connector	Options	Unimed-EVO	ORIGINAL OEM #	EVOTEC OEM
	<p>To Monitor:</p>  <p>To Novamatrix Sensor:</p> 	2.2m Adapter	EV708-03		ES0062NE-L

Pace Tech Direct Connect Sensors – See Goldway

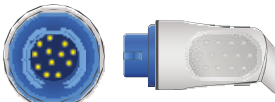
Philips Direct Connect Sensors

Models	Connector	Options	Unimed-EVO	ORIGINAL OEM #	EVOTEC OEM
78352A, 78352C, 78354A, 78354C, 78834C, M1020A, M1025A, M1025B, M1092A, M1094B, M1204A, M1205A, M1350B, M1722A, M1722B, M1190A, M1723A, M1723B, M1732A, M1732B, M2475B, M3046A M4, V24E, Codemaster, HeartStart XL, Agilent 50XM Fetal Monitor		Adult Clip	EV410-20	M1190A	ES0003B-L
		Adult Soft	EV410S-20		ES0003D-L
		Pediatric Clip	EV110-20		ES0003C-L
		Pediatric Soft	EV110S-20		ES0003E-L
		Neonate Wrap	EV310-20		ES0003I-L
		Multi-Site	EV810-20		ES0003G-L
C1, C3, M3, M4, MP20, MP30, MP40, MP50, MP60, MP70, MP80, MP90, VM4, VM6, VM8, HPViridia 24C, Philips HeartStart defibrillator and IntelliVue; Goldway G40; Solaris NT2A, NT2C		Adult Clip	EV410-91	M1196A	ES0015B-L
		Adult Soft	EV410S-91	M1191AL, M1191BL	ES0015D-L
		Pediatric Clip	EV110-91		ES0015C-L
		Pediatric Soft	EV110S-91		ES0015E-L
		Neonate Wrap	EV310-91		ES0015I-L
		Adult Ear Clip	EV910-91		ES0015G-L +CLIP
MP20, MP30, MP40, MP50, MP60, MP70, MP90, VN4, VN6, VN8 with Masimo technology		Adult Clip	EV410-91M		ES0015M-L
		Adult Soft	EV410S-91M		ES0015DM-L
		Pediatric Clip	EV110-91M		ES0015CM-L
		Pediatric Soft	EV110S-91M		ES0015EM-L
		Neonate Wrap	EV310-91M		ES0015IM-L
		Multi-Site	EV810-91M		ES0015GM-L



Philips Short Sensors



Models	Connector	Options	Unimed-EVO	ORIGINAL OEM #	EVOTEC OEM
Viridia 24C, C1, C3, M3, M4, MP20, MP30, MP40, MP50, VM4, VM6, VM8, HeartStart MRx SureSigns VS3		Adult clip	EV403-91		ES0015B-S
		Adult soft	EV403S-91	M1191A, M1191B, M4531A,	ES0015D-S
		Pediatric clip	EV103-91		ES0015C-S
		Pediatric soft	EV103S-91	M1192A	ES0015E-S
		Infant soft	EV203S-91	M1195A	ES0015I=S
		Neonate Wrap	EV303-91	M1193A	ES0015N-S
		Adult Ear Clip	EV903-91	M1194A	ES0015G-S+CLIP
		Multi-Site	EV803-91		ES0015G-S



Philips Adapter Cables



Models	Connector	Options	Unimed-EVO	ORIGINAL OEM #	EVOTEC OEM
Heartstream XL, IntelliVue MP70, M2601A, M3000A, M1020B, M3000A/M3001A, M3002A MMS X2, M8102A MP2, MP5	To Monitor: To Nellcor non-Oximax Sensor: 	2.2 M Adapter	EV708-43	M1943AL, TE1514,	SEE M1943NL
	To Monitor: To Nellcor Oximax Sensor: 	3 M Adapter	EV710P-43	M1943NL	ES0015OX-L
M2601A, M3000A, M3500 B, M4735A	To Monitor: To Philips Sensor: 	2.2M Adapter	EV708-41	M1941A, M1941B	ES0015PH-L
Nellcor	To Monitor: To Nellcor non-Oximax Sensor: 	2.2M Adapter	EV708-43M		ES708-43M

Philips Adapter Cables (Continued)

Models	Connector	Options	Unimed-EVO	ORIGINAL OEM #	EVOTEC OEM
Philips IntelliVue FAST-SpO2 M-Technology	To Monitor:  To Novamatrix Sensor: 	2.2 M Adapter	EV708M-43P	LNOP MP12, 2282, M1020- 61100	ES708M-43P

Models	Connector	Options	Unimed-EVO	ORIGINAL OEM #	EVOTEC OEM
SureSigns VS3 M - Technology	To Monitor:  To Masimo LNCS Sensor: 	2.2m Adapter	EV708M-43	LNC MP10, 2281, 9898031 48221	ES708M-43

Models	Connector	Options	Unimed-EVO	ORIGINAL OEM #	EVOTEC OEM
78352C, 78354C, 78834C, M1020A, M1025B, M1205A, M1350, M1722A/B, M1732A/B, M2475B, Viridia A1, Viridia A3 Nellcor Technology	To Monitor:  To Nellcor non-Oximax Sensor: 	2.2m Adapter	EV708-20	M1900A, M1900B	ES0003OX-L

Models	Connector	Options	Unimed-EVO	ORIGINAL OEM #	EVOTEC OEM
M1020A, M2475B, M1732A/B, M1722A/B, M1020A, 78833C, 78833A, 78834A, 78352C, 78352A Philips Technology	To Monitor:  To Philips Sensor: 	2.2m Adapter	EV708-40	M1940A, M1940B	ES0003PH-L

Physio Control (See Masimo and Nellcor Adapter Cables)

Schiller Direct Connect Sensors

Models	Connector	Options	Unimed-EVO	ORIGINAL OEM #	EVOTEC OEM
Argus CM8, SM783, SM784, SM785, TM910		Adult Clip	EV410-17		ES0028B-L
		Adult Soft	EV410S-17		ES0028D-L
		Pediatric Clip	EV110-17		ES0028C-L
		Pediatric Soft	EV110S-17		ES0028E-L
		Neonate Wrap	EV310-17		ES0028I-L
		Multi-Site	EV810-17		ES0028G-L

Schiller Direct Connect Sensors (Continued)

Models	Connector	Options	Unimed-EVO	ORIGINAL OEM #	EVOTEC OEM
TM7, Argus Pro, Argus LCM with Masimo technology		Adult Clip	EV410-17M		ES0118B-L
		Adult Soft	EV410S-17M		ES0118D-L
		Pediatric Clip	EV110-17M		ES0118C-L
		Pediatric Soft	EV110S-17M		ES0118E-L
		Neonate Wrap	EV310-17M		ES0118I-L
		Multi-Site	EV810-17M		ES0118G-L

Schiller Adapter Cables





Models	Connector	Options	Unimed-EVO	ORIGINAL OEM #	EVOTEC OEM
Argus TM-7	To Monitor: To Nellcor non-Oximax Sensor: 	2.2M Foot Adapter	EV708-17M		ES0028NE-L
	To Monitor: To Masimo LNOP Sensor: 	2.2M Adapter	EV708M-17P		ES0118MA-L
Also for use as Welch Allyn interface cable	To Monitor: To Masimo LNCS Sensor: 	2.2M Adapter	EV708M-17	008-0692-02	ES708M-17

Siemens (See Drager)

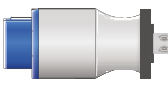

Simed Direct Connect Sensors

Models	Connector	Options	Unimed-EVO	ORIGINAL OEM #	EVOTEC OEM
90351-0/6, 90309, 90465, 0466, 90489, 90651-A, IM77, 90308, PC Scout		Adult Clip	EV410-04	90651A-08, 015-0130-00,	ES0120B-L
		Adult Soft	EV410S-04		ES0120D-L
		Pediatric Clip	EV110-04		ES0120C-L
		Pediatric Soft	EV110S-04		ES0120E-L
		Neonate Wrap	EV310-04		ES0120I-L
		Multi-Site	EV810-04		ES0120G-L

Sino Hero Direct Connect Sensors

Models	Connector	Options	Unimed-EVO	ORIGINAL OEM #	EVOTEC OEM
S80 See also BLT	 5 PIN 1 BIT REDEL	Adult Clip		015-0130-01	ES0161B-L
		Adult Soft			ES0161D-L
		Pediatric Clip			ES0161C-L
		Pediatric Soft			ES0161E-L
		Neonate Wrap			ES0161I-L
		Multi-Site			ES0161G-L
S60, ME, M6, M5, M3	 	Adult Clip			ESO151B-L
		Adult Soft			ESO151D-L
		Pediatric Clip			ESO151C-L
		Pediatric Soft			ESO151E-L
		Neonate Wrap			ESO151I-L
		Multi-Site			ESO151G-L
M7000, M900, M9500 A8 MODULAR *DIGITAL TECH	 	Adult Clip	EV410-68D0		ES0150B-L
		Adult Soft	EV410S-68D0		ES0150D-L
		Pediatric Clip	EV110-68D0		ES0150C-L
		Pediatric Soft	EV110S-68D0		ES0150E-L
		Neonate Wrap	EV310-68D0		ES0150I-L
		Multi-Site	EV810-68D0		ES0150G-L

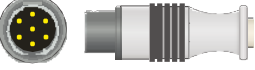
Welch Allyn Adapter Cables *(Also See Nellcor and Schiller Adapter Cables)*

Models	Connector	Options	Unimed-EVO	ORIGINAL OEM #	EVOTEC OEM
PIC 30, PIC 40 and PIC 50 with Oximax technology	To Monitor:  To Nellcor Oximax Sensor: 	1m Adapter	EV704P-104	001966-E	ES704P-104

Yonker Direct Connect Sensors

Models	Connector	Options	Unimed-EVO	ORIGINAL OEM #	EVOTEC OEM
8000 series monitors		Adult Clip			ES0007B-L
		Adult Soft			ES0007D-L
		Pediatric Clip			ES0007C-L
		Pediatric Soft			ES0007E-L
		Neonate Wrap			ES0007I-L
		Multi-Site			ES0007G-L

Zoll *(See Masimo and Nellcor)*

SpO2 Adult Ear Clip

Description	Image	Unimed-EVO	ORIGINAL OEM	EVOTEC OEM
Attachment for Multi-Sites to apply pulseox sensor on an adult ear lobe.		EVEC-010	D-YSE	ESear

Silicone Wrap

Description	Image	Unimed-EVO	ORIGINAL OEM	EVOTEC OEM
Silicone Wrap for G – series Neonatal applications				ESwrap

Soft Application

Description	Image	Unimed-EVO	ORIGINAL OEM	EVOTEC OEM
Posey Wrap for soft application				ESposey

LEFT BLANK